

GP Batteries

Data Sheet

Rechargeable Nickel Metal Hydride Battery

Model: GP65AAAHC

Revision History

Revision	Date	Initiator	Change Description
01	2014-10-28	Dong Zhou	1. New form

Prepared by	Checked by	Approver
RD Engineer	RD Manager	SM
Dong Zhou	Ling Guan	Vivian Fong
Date: 2014-10-28	Date: 2014-10-28	Date:2014-10-28

GPI International Limited

Gold Peak Building, 8/F, 30 Kwai Wing Road,
Kwai Chung, New Territories, Hong Kong.
Tel: (852) 2484 3333 Fax: (852) 24805912
Email: gpii@goldpeak.com
Website: <http://www.gpbatteries.com>

Model No.: GP65AAHC

Type	: Rechargeable Nickel Metal Hydride Cylindrical Cell
Nominal Dimension (with Sleeve)	: $\Phi = 10.5\text{mm}$ H = 44.5mm
Applications	: Recommended discharge current 65 to 1950mA
Nominal Voltage	: 1.2V
Capacity	: Nominal: 650mAh Minimum: 650mAh Typical: 670mAh When discharged at 130mA to 1.0V at 20°C
Charging Condition	: 65mA for 16 hrs at 20°C
Charging Retention	: 80% of nominal capacity after cell storage at 20°C for 12 months When discharged at 130mA to 1.0V at 20°C
Fast Charge	: 325mA to 650mA (0.5 to 1C) charge termination control recommended control parameters: - ΔV : 0-5mV DT/dt : 0.8°C/min (0.5 to 0.9C) 0.8 - 1°C/min (1C) TCO : 45 - 50°C Timer : 105% nominal input (for ref. only)
Service Life	: >500 cycles (IEC standard)
Continuous Overcharge	: 65mA maximum current for 1 year. No conspicuous deformation and/or leakage
Weight	: 13.0g
Internal Resistance	: Average 36m Ω upon fully charged (Max. 50m Ω) at 1000Hz
Max. Charging Voltage	: 1.5V at 65mA charging
Ambient Temperature Range	: Standard Charge : 0 to 45°C Fast Charging : 10 to 45°C Discharge : -20 to 50°C Storage : -20 to 35°C

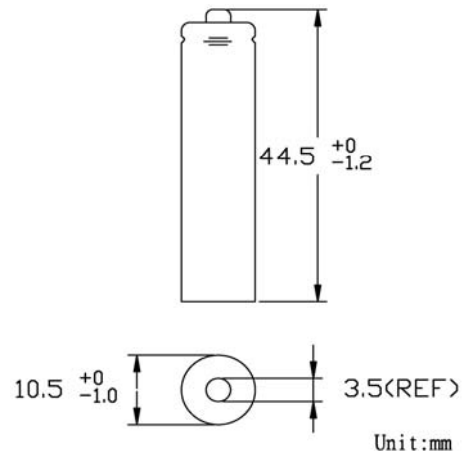

Low Rate Discharge

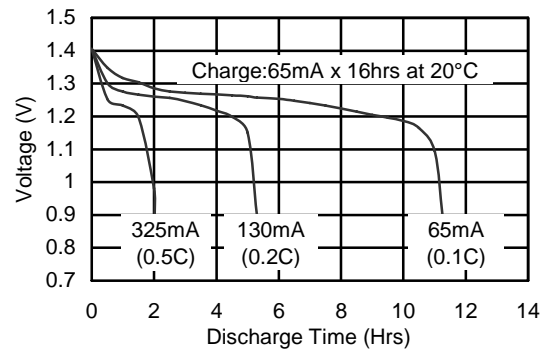

High Rate Discharge

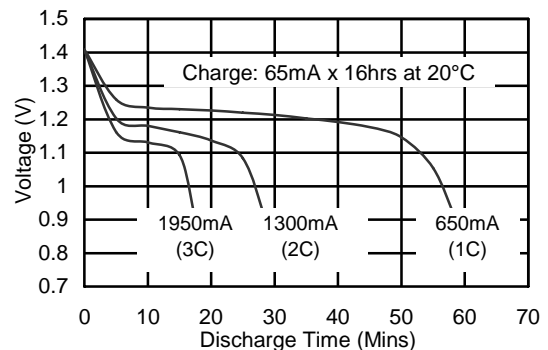

Fast Charge (Charge Control Required)

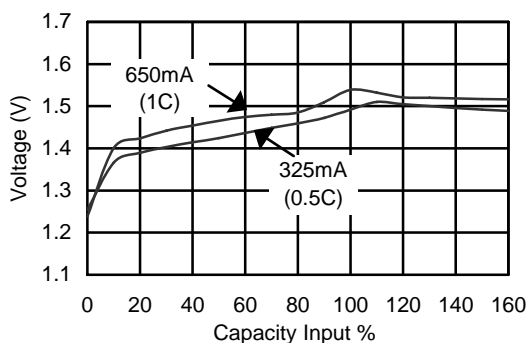

The information (subject to change without prior notice) contained in this document is for reference only and should not be used as a basis for product guarantee or warranty. For applications other than those described here, please consult your nearest GP Sales and Marketing Office or Distributors.